

NATURAL SCIENCES  
ADMISSIONS ASSESSMENT

D568/12

2022

60 minutes

## SECTION 2

## INSTRUCTIONS TO CANDIDATES

Please read these instructions carefully, but do not open this question paper until you are told that you may do so. This paper is Section 2 of 2.

A separate answer sheet is provided for this paper. Please check you have one. You also require a soft pencil and an eraser.

Please complete the answer sheet with your candidate number, centre number, date of birth, and name.

This paper contains **three** parts: **X**, **Y** and **Z**.

All candidates should complete only **one** part chosen from:

<b>Part X</b>	Physics
<b>Part Y</b>	Chemistry
<b>Part Z</b>	Biology

Each part has 20 multiple-choice questions. There are no penalties for incorrect responses, only marks for correct answers, so you should attempt **all** 20 questions in your chosen part. Each question is worth one mark.

For each question, choose the **one** option you consider correct and record your choice on the separate answer sheet. If you make a mistake, erase thoroughly and try again.

You **must** complete the answer sheet within the time limit.

You can use the question paper for rough working, but **no extra paper** is allowed. Only your responses on the answer sheet will be marked.

A Periodic Table is included.

Dictionaries and calculators are NOT permitted.

**Please wait to be told you may begin before turning this page.**

*This question paper consists of 69 printed pages and 7 blank pages.*



**BLANK PAGE**

**Paper content**

PART X Physics.....	7
PART Y Chemistry.....	29
PART Z Biology.....	51

**BLANK PAGE**

		symbol atomic number																																	
		1	2	3	4	5	6	7	8	9	10	11	12	13	14	15	16	17	18																
<b>H</b>	1																																		
<b>He</b>	2																																		
<b>Li</b>	3	<b>Be</b>	4																																
<b>Na</b>	11	<b>Mg</b>	12																																
<b>K</b>	19	<b>Ca</b>	20	<b>Sc</b>	21	<b>Ti</b>	22	<b>V</b>	23	<b>Cr</b>	24	<b>Mn</b>	25	<b>Fe</b>	26	<b>Co</b>	27	<b>Ni</b>	28	<b>Cu</b>	29	<b>Zn</b>	30	<b>Ga</b>	31	<b>Ge</b>	32	<b>As</b>	33	<b>Se</b>	34	<b>Br</b>	35	<b>Kr</b>	36
<b>Rb</b>	37	<b>Sr</b>	38	<b>Y</b>	39	<b>Zr</b>	40	<b>Nb</b>	41	<b>Mo</b>	42	<b>Tc</b>	43	<b>Ru</b>	44	<b>Rh</b>	45	<b>Pd</b>	46	<b>Ag</b>	47	<b>Cd</b>	48	<b>In</b>	49	<b>Sn</b>	50	<b>Sb</b>	51	<b>Te</b>	52	<b>I</b>	53	<b>Xe</b>	54
<b>Cs</b>	55	<b>Ba</b>	56	<i>Lanthanoids</i> 57-71		<b>Hf</b>	72	<b>Ta</b>	73	<b>W</b>	74	<b>Re</b>	75	<b>Os</b>	76	<b>Ir</b>	77	<b>Pt</b>	78	<b>Au</b>	79	<b>Hg</b>	80	<b>Tl</b>	81	<b>Pb</b>	82	<b>Bi</b>	83	<b>Po</b>	84	<b>At</b>	85	<b>Rn</b>	86
<b>Fr</b>	87	<b>Ra</b>	88	<i>Actinoids</i> 89-103		<b>Rf</b>	104	<b>Db</b>	105	<b>Sg</b>	106	<b>Bh</b>	107	<b>Hs</b>	108	<b>Mt</b>	109	<b>Ds</b>	110	<b>Rg</b>	111	<b>Cn</b>	112	<b>Nh</b>	113	<b>Fl</b>	114	<b>Mc</b>	115	<b>Lv</b>	116	<b>Ts</b>	117	<b>Og</b>	118

<b>Lanthanoids</b>	<b>La</b>	57	<b>Ce</b>	58	<b>Pr</b>	59	<b>Nd</b>	60	<b>Pm</b>	61	<b>Sm</b>	62	<b>Eu</b>	63	<b>Gd</b>	64	<b>Tb</b>	65	<b>Dy</b>	66	<b>Ho</b>	67	<b>Er</b>	68	<b>Tm</b>	69	<b>Yb</b>	70	<b>Lu</b>	71
<b>Actinoids</b>	<b>Ac</b>	89	<b>Th</b>	90	<b>Pa</b>	91	<b>U</b>	92	<b>Np</b>	93	<b>Pu</b>	94	<b>Am</b>	95	<b>Cm</b>	96	<b>Bk</b>	97	<b>Cf</b>	98	<b>Es</b>	99	<b>Fm</b>	100	<b>Md</b>	101	<b>No</b>	102	<b>Lr</b>	103

**BLANK PAGE**

## **PART X Physics**

- 1 The diagram shows an object of mass 2.4 kg on a smooth horizontal surface.

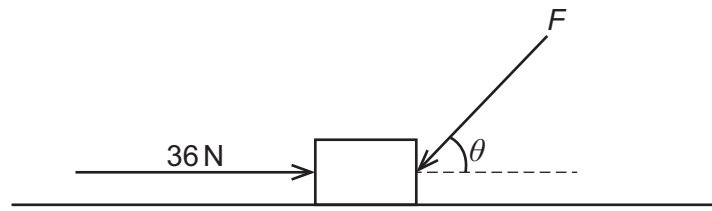

A force  $F$  acts on the object at an acute angle  $\theta$  to the horizontal, where  $\tan \theta = \frac{4}{3}$ .

A force of 36 N acts on the object towards the right.

The object is in equilibrium.

What is the magnitude of the normal contact force exerted on the object by the surface?

(gravitational field strength =  $10 \text{ N kg}^{-1}$ )

- A 24 N
- B 27 N
- C 48 N
- D 51 N
- E 72 N
- F 75 N



- 2 The length of a spring when no force acts on it is  $L$ . The spring constant of the spring is  $3.0 \times 10^3 \text{ N m}^{-1}$ .

The spring is on the floor of an accelerating lift (elevator), and the spring supports a 30 kg mass.

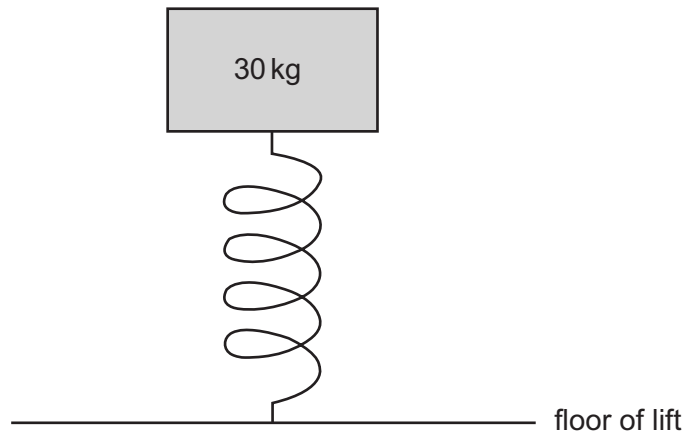

The lift is accelerating downwards at  $2.0 \text{ m s}^{-2}$ .

What is the difference between  $L$  and the length of the spring when the lift is accelerating downwards?

(gravitational field strength =  $10 \text{ N kg}^{-1}$ ; the spring obeys Hooke's law)

- A 0 cm
- B 2.0 cm
- C 8.0 cm
- D 10 cm
- E 12 cm

- 3** Electrical energy is transmitted at high voltage to a remote farm using an overhead power cable. Each of the two wires in the cable has a resistance of  $2.5\ \Omega$ . The step-down transformer in the farm has a voltage ratio of 5.0. The transformer is ideal and 100% efficient. It supplies a power of 40 kW to a resistive load at the farm at a voltage of 250 V.

What is the rate at which electrical energy is transferred to thermal energy in the overhead cable?

- A** 1.28 kW
- B** 2.56 kW
- C** 5.12 kW
- D** 32 kW
- E** 64 kW
- F** 128 kW

4 A wave is passing through a medium.

A particle of the medium has zero displacement from its equilibrium position at 0.12 s intervals, and at no other times.

The wavelength of the wave is greater than 10.0 m.

Two points are 5.0 m apart along the direction of travel of the wave.

The phase difference between the particles at the two points at the same instant is  $\frac{\pi}{3}$  radians.

What is the speed of the wave?

**A**  $1.8 \text{ m s}^{-1}$

**B**  $3.6 \text{ m s}^{-1}$

**C**  $7.2 \text{ m s}^{-1}$

**D**  $62.5 \text{ m s}^{-1}$

**E**  $125 \text{ m s}^{-1}$

**F**  $250 \text{ m s}^{-1}$

- 5 Three light springs, P, Q and R, are identical.

Springs P and Q are connected in series as shown. A downwards force  $T$  is applied to the lower end.

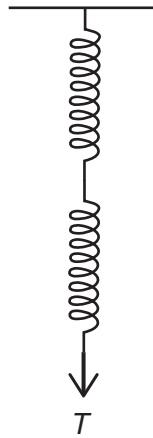

Spring R is cut into four equal lengths, and the four pieces arranged symmetrically as shown. The two connecting bars have negligible mass. A downwards force  $F$  is applied to the centre of the lower bar.

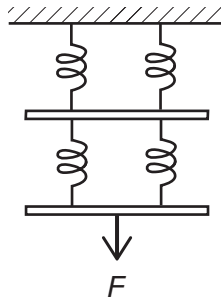

The total extensions of the two systems are equal. The springs obey Hooke's law.

Which expression gives  $T$  in terms of  $F$ ?

- A  $\frac{F}{16}$
- B  $\frac{F}{8}$
- C  $\frac{F}{4}$
- D  $\frac{F}{2}$
- E  $2F$
- F  $4F$
- G  $8F$
- H  $16F$

- 6 A nylon cube resting on a horizontal surface has a volume of  $64 \text{ cm}^3$ .

A force  $F$  is applied vertically downwards on the top face of the cube so that it compresses the height by  $x$ .

The graph shows the variation of  $F$  with  $x$ .

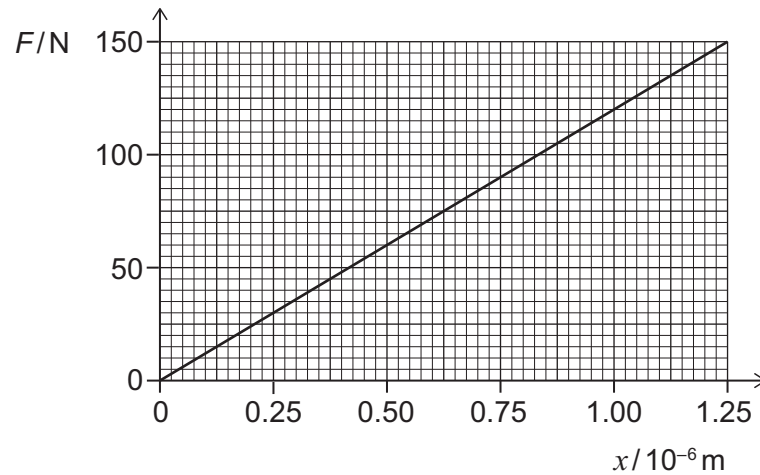

What is the Young modulus of the nylon?

(Assume that changes in horizontal cross-sectional area are negligible.)

- A  $7.7 \times 10^3 \text{ Pa}$
- B  $4.8 \times 10^6 \text{ Pa}$
- C  $9.6 \times 10^6 \text{ Pa}$
- D  $1.2 \times 10^8 \text{ Pa}$
- E  $1.5 \times 10^9 \text{ Pa}$
- F  $3.0 \times 10^9 \text{ Pa}$
- G  $1.9 \times 10^{12} \text{ Pa}$

- 7 Five lampposts alongside a straight road are positioned at uniform intervals of 60 m.

A motorbike travelling at a constant velocity passes the first lamppost at time  $t = 0$  s. It passes the fifth lamppost at  $t = 20$  s.

A car travelling in the same direction as the motorbike is accelerating at  $6.0 \text{ m s}^{-2}$ . At time  $t = 0$  s the car passes the first lamppost at a velocity of  $3.0 \text{ m s}^{-1}$ .

At what time  $t$  does the car overtake the motorbike?

- A 1.5 s
- B 2.0 s
- C 2.5 s
- D 3.0 s
- E 3.5 s
- F 4.0 s
- G 5.0 s

- 8 An electrical appliance has an input power  $P$  which is a function of time  $t$  during the first 10 seconds after it is switched on.

This function is

$$P = 3t^2 + 4t$$

where  $P$  is in watts and  $t$  is in seconds.

The appliance is switched on at time  $t = 0$ .

The appliance has a constant efficiency of 90%.

What is the energy **wasted** by the appliance during the period  $t = 2.0\text{s}$  to  $t = 3.0\text{s}$  after it is switched on?

- A 0.60J
- B 0.70J
- C 1.9J
- D 2.9J
- E 4.5J
- F 17J
- G 26J
- H 41J

- 9 A solid cylinder is made of transparent glass of refractive index  $\frac{2}{\sqrt{3}}$ . It is surrounded by air.

A ray of light travelling in air hits the cylinder at the centre of one circular face at a non-zero angle  $\theta$  to the normal, and refracts as it enters the cylinder.

The ray then strikes the curved surface of the cylinder at an angle of incidence equal to the critical angle.

What is the value of  $\theta$ ?

- A  $\sin^{-1} \frac{\sqrt{3}}{4}$
- B  $\sin^{-1} \frac{1}{\sqrt{3}}$
- C  $\sin^{-1} \frac{2}{\sqrt{6}}$
- D  $\sin^{-1} \frac{\sqrt{3}}{2}$
- E  $\sin^{-1} 1$



- 10** An object of mass 20 kg is acted on by a force that varies in magnitude during the time interval  $t = 0$  s to  $t = 1.0$  s.

The force causes the object's displacement  $x$  to change with time  $t$  according to the relationship

$$x = -t^3 - 3t^2 + 4$$

where  $x$  is in metres and  $t$  is in seconds.

What is the magnitude of the impulse on the object over this time interval?

- A**  $2.8 \text{ kgms}^{-1}$
- B**  $9.0 \text{ kgms}^{-1}$
- C**  $55 \text{ kgms}^{-1}$
- D**  $80 \text{ kgms}^{-1}$
- E**  $100 \text{ kgms}^{-1}$
- F**  $180 \text{ kgms}^{-1}$

- 11 Two small hard spheres of mass  $m$  and  $2m$  are suspended side by side from light vertical strings of length  $l$ . The more massive sphere is raised so that its string is horizontal, and then released. It swings through  $90^\circ$  and strikes the smaller sphere. The two spheres stick together, and rise to a maximum height  $h$  as shown in the diagram.

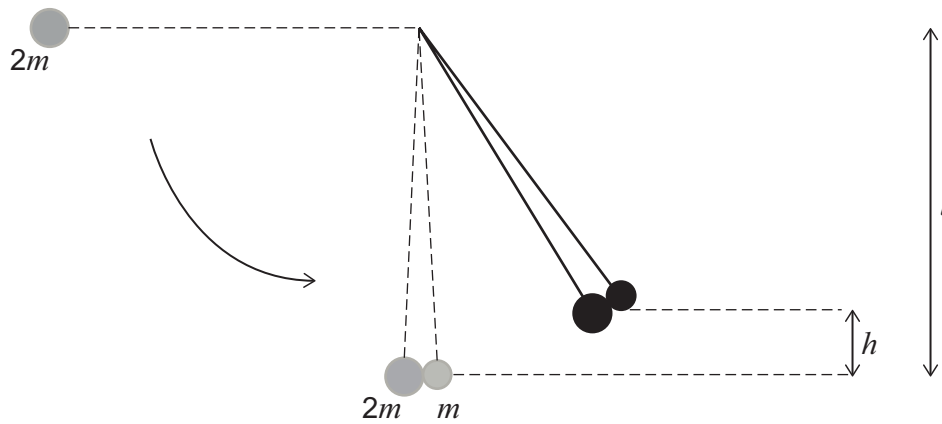

[diagram not to scale]

Which expression gives the height  $h$  in terms of  $l$ ?

(Assume that air resistance is negligible.)

- A  $\frac{4l}{27}$
- B  $\frac{8l}{27}$
- C  $\frac{4l}{9}$
- D  $\frac{2l}{3}$
- E  $\frac{8l}{9}$
- F  $l$
- G  $2l$

- 12 Three resistance wires X, Y and Z, made from the same metal, are connected to each other and to a circular plastic ring as shown.

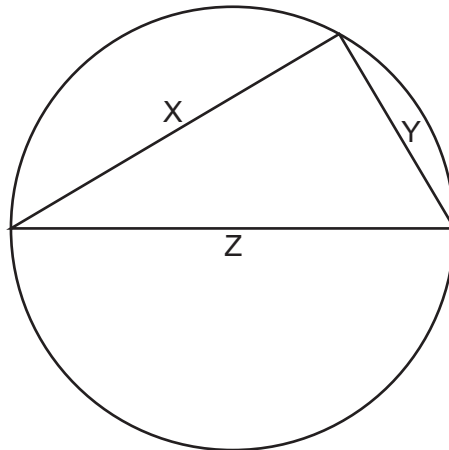

[diagram not to scale]

Wires X and Y each have twice the diameter of wire Z.

Wire X is 12 cm long. Wire Z is 15 cm long and is connected across a diameter of the ring.

A power supply is connected to the two corners of the triangle that lie on the diameter.

What is the value of the ratio

$$\frac{\text{current in X}}{\text{current in Z}} ?$$

- A  $\frac{1}{5}$   
 B  $\frac{7}{20}$   
 C  $\frac{7}{10}$   
 D  $\frac{5}{7}$   
 E  $\frac{7}{5}$   
 F  $\frac{10}{7}$   
 G  $\frac{20}{7}$   
 H 5

- 13** A light rope has cross-sectional area  $6.0 \times 10^{-8} \text{ m}^2$  and unstretched length 0.24 m.

The rope is fixed horizontally between two supports that are 0.24 m apart.

When a 1.0 kg mass is suspended from the middle of the rope, the vertical displacement of the middle of the rope from its original position is 0.050 m.

The rope obeys Hooke's law. Assume that changes in cross-sectional area are negligible.

What is the Young modulus of the material from which the rope is made?

(gravitational field strength =  $10 \text{ N kg}^{-1}$ )

- A**  $5.2 \times 10^8 \text{ N m}^{-2}$
- B**  $8.0 \times 10^8 \text{ N m}^{-2}$
- C**  $1.0 \times 10^9 \text{ N m}^{-2}$
- D**  $1.3 \times 10^9 \text{ N m}^{-2}$
- E**  $2.0 \times 10^9 \text{ N m}^{-2}$
- F**  $2.6 \times 10^9 \text{ N m}^{-2}$
- G**  $5.2 \times 10^9 \text{ N m}^{-2}$

- 14 The three graphs show the displacement, velocity and acceleration against time for an object moving in a straight line.

The time axis is shown to the same scale on all three graphs.

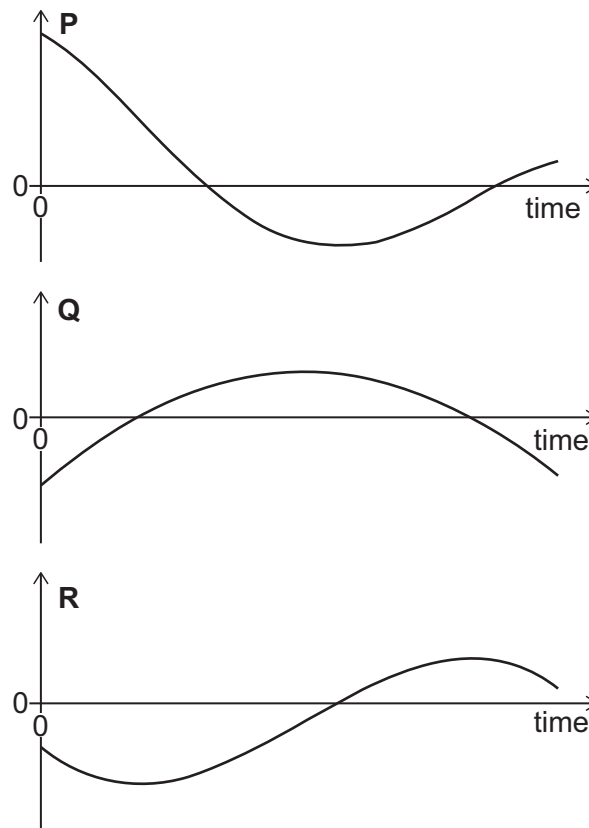

Which graph represents which quantity?

	<i>graph P</i>	<i>graph Q</i>	<i>graph R</i>
<b>A</b>	acceleration	displacement	velocity
<b>B</b>	acceleration	velocity	displacement
<b>C</b>	displacement	acceleration	velocity
<b>D</b>	displacement	velocity	acceleration
<b>E</b>	velocity	acceleration	displacement
<b>F</b>	velocity	displacement	acceleration

- 15** A system of light springs that does not obey Hooke's law has an unstretched length of 2.0 m. The extension  $x$  of the system is related to the force  $F$  applied to it by

$$F = px^2$$

where  $p$  is a constant.

A force of 2400 N increases the length of the system to 2.2 m.

How much work is done in increasing the length of the system from 3.0 m to 4.0 m?

- A** 1.2 kJ
- B** 60 kJ
- C** 70 kJ
- D** 120 kJ
- E** 140 kJ
- F** 740 kJ

- 16 The diagram shows a circuit that includes two batteries, each with negligible internal resistance.

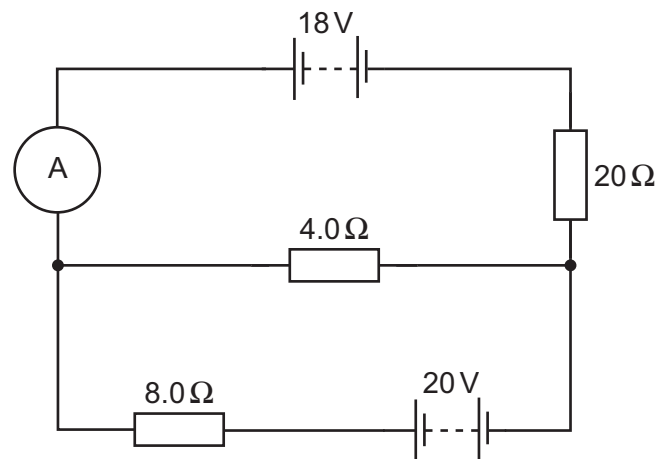

What is the reading on the ammeter?

- A 0.0029 A
- B 0.0071 A
- C 0.063 A
- D 0.083 A
- E 0.50 A
- F 0.65 A
- G 1.2 A
- H 2.0 A

- 17 The upper diagram shows the equilibrium positions of nine equally spaced particles in a medium.

The lower diagram shows the positions of the same nine particles when a longitudinal wave is travelling through the medium. The wave is shown at time  $t = 0$ , travelling to the right.

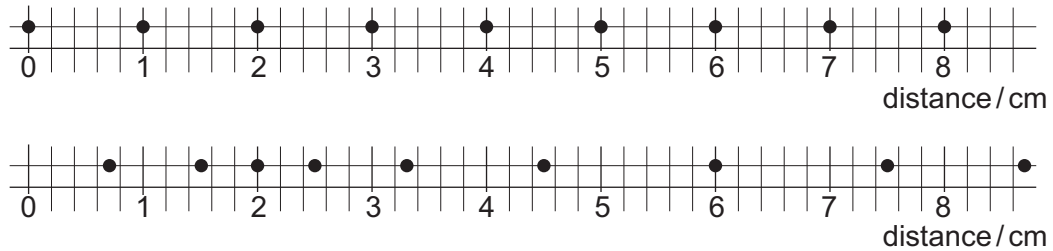

The frequency of the wave is 0.5 Hz.

Which graph represents the displacements of the particles at a later time  $t = 0.5$  s?

(On the graphs, positive displacement values represent particle displacements to the right.)

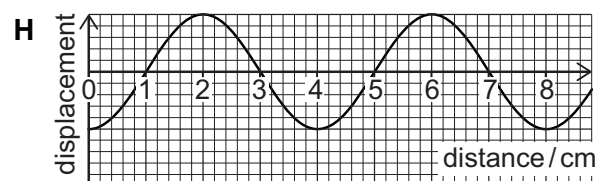
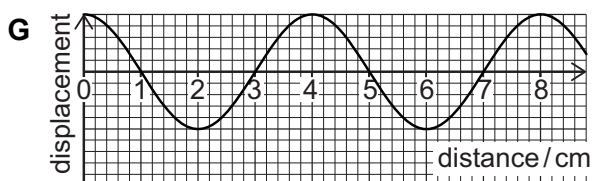
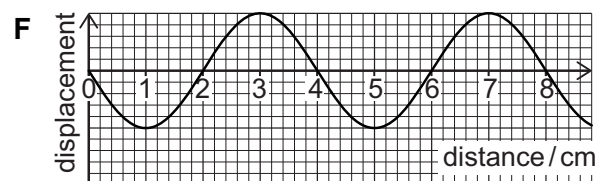
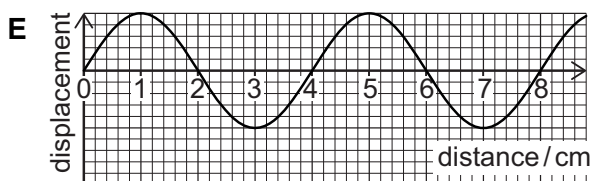
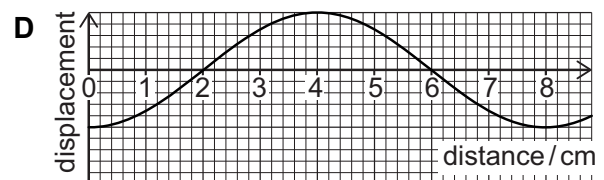
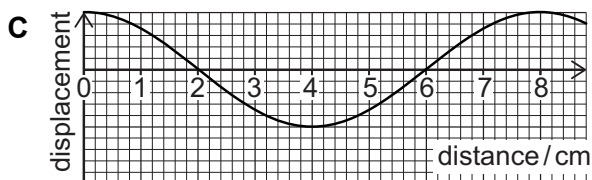
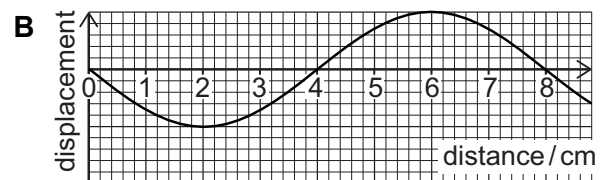
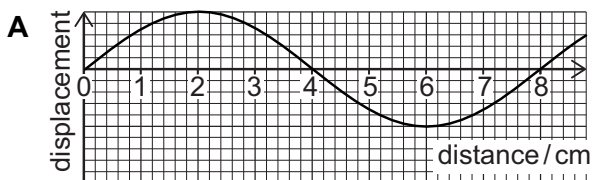



18 A power supply with constant emf and internal resistance  $r$  is connected to an external resistor.

The efficiency of the system is defined as

$$\text{efficiency} = \frac{\text{power dissipated by external resistor}}{\text{total power supplied by cell}}$$

Which graph shows how the efficiency varies with the resistance of the external resistor?

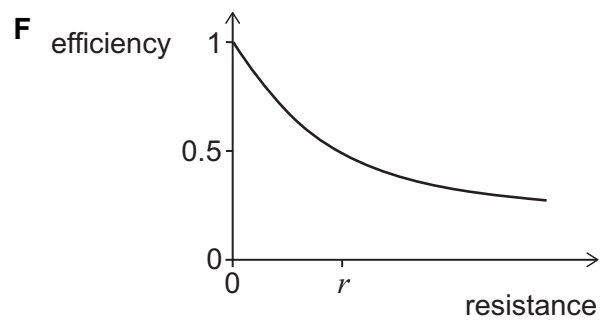
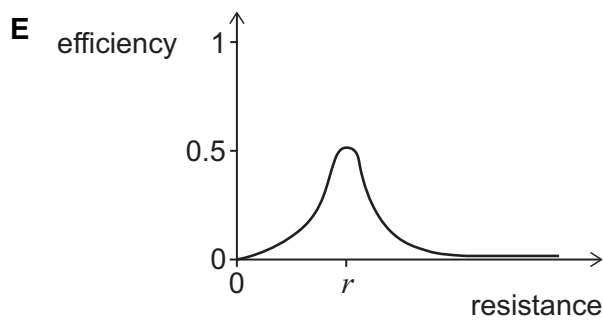
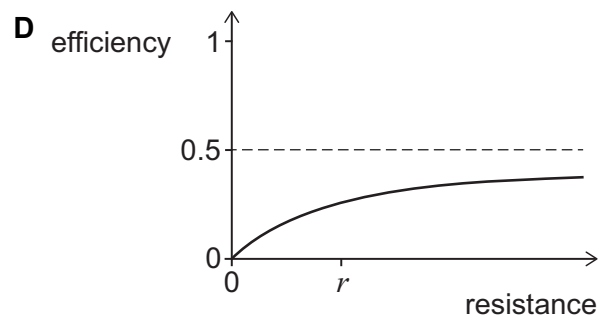
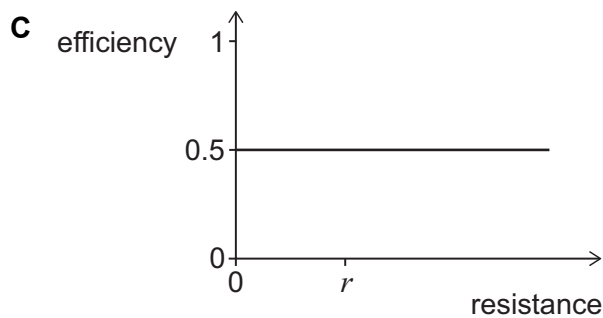
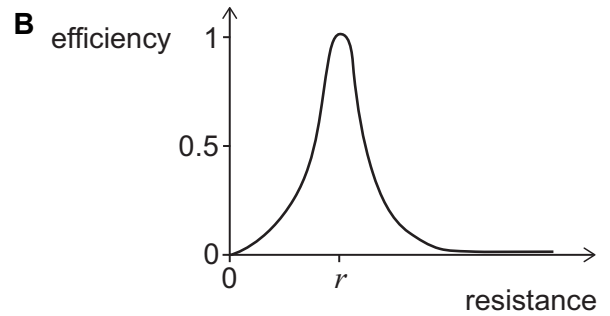
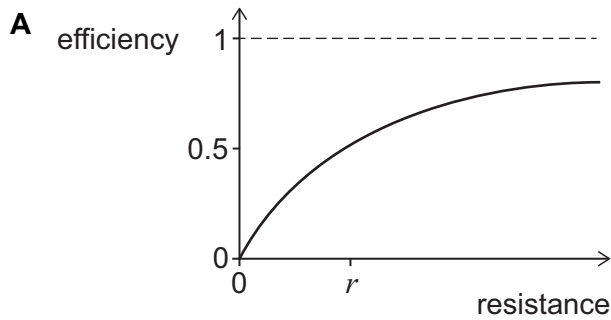

- 19** A 10 kg projectile is launched from ground level at an angle of  $60^\circ$  above the horizontal, with an initial speed of  $12 \text{ m s}^{-1}$ . The horizontal component of its velocity is to the right.

At the point during its flight when the vertical component of its velocity is zero, the projectile splits into two pieces, P and Q, each of mass 5 kg.

Immediately after the projectile splits, piece P has velocity  $14 \text{ m s}^{-1}$  to the right.

What is the speed of piece Q immediately before it hits the ground?

(Assume that air resistance is negligible, and that the ground is horizontal.)

- A**  $2 \text{ m s}^{-1}$
- B**  $\sqrt{31} \text{ m s}^{-1}$
- C**  $6\sqrt{3} \text{ m s}^{-1}$
- D**  $4\sqrt{7} \text{ m s}^{-1}$
- E**  $2\sqrt{43} \text{ m s}^{-1}$
- F**  $4\sqrt{13} \text{ m s}^{-1}$
- G**  $4\sqrt{19} \text{ m s}^{-1}$
- H**  $2\sqrt{127} \text{ m s}^{-1}$

- 20 The density  $\rho$  of a sphere varies from its centre to its surface according to the equation

$$\rho = \rho_0 \left( 1 - \frac{x}{2R} \right)$$

where  $x$  is the distance from its centre,  $R$  is its radius and  $\rho_0$  is the density at its centre.

What is the mass of the sphere?

(the surface area of a sphere of radius  $x$  is equal to  $4\pi x^2$ )

- A  $\frac{2\pi R^3 \rho_0}{3}$
- B  $\frac{5\pi R^3 \rho_0}{6}$
- C  $\frac{8\pi R^3 \rho_0}{9}$
- D  $\pi R^3 \rho_0$
- E  $\frac{29\pi R^3 \rho_0}{24}$
- F  $\frac{19\pi R^3 \rho_0}{15}$
- G  $\frac{4\pi R^3 \rho_0}{3}$
- H  $2\pi R^3 \rho_0$

**BLANK PAGE**

## **PART Y Chemistry**

- 21** In this question, consider only the elements potassium, rubidium, calcium, strontium, bromine and iodine. Assume that there are similar trends in physical properties in Periods 4 and 5 as there are in Periods 2 and 3.

Consider the enthalpy change for the process:

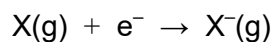

The element for which this process is most exothermic reacts with the metal with the highest first ionisation energy.

What is the relative molar mass ( $M_r$ ) of the product from this reaction?

( $A_r$  values: K = 39; Rb = 86; Ca = 40; Sr = 88; Br = 80; I = 127)

- A** 119
- B** 120
- C** 166
- D** 200
- E** 213
- F** 248
- G** 294
- H** 342

- 22 The following diagram gives the mass spectra of samples of the elements gallium (Ga) and chlorine (Cl).

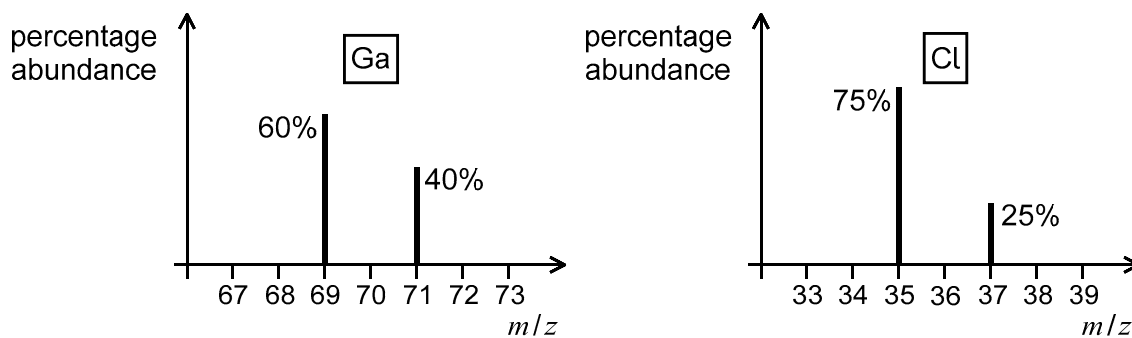

Gaseous gallium chloride has a formula of  $\text{GaCl}_3$ .

The mass spectrum of gallium chloride shows peaks at different mass-to-charge ratio ( $m/z$  value).

What is the abundance ratio of the molecular ion  $\text{GaCl}_3^+$  with the largest  $m/z$  value to the smallest  $m/z$  value?

- A 2:9
- B 2:16
- C 2:36
- D 2:54
- E 2:81

- 23** 4.00 g of bromine reacts with excess fluorine at temperatures over 150 °C to form 8.75 g of compound X only. The molecular formula of X is the same as the empirical formula.

Using the VSEPR model, what is the smallest bond angle in compound X?

( $A_r$  values: Br = 80; F = 19)

- A** 120°
- B** in the range 114°-119°
- C** 109.5°
- D** in the range 104°-109°
- E** 90°
- F** in the range 84°-89°



- 24 An aqueous solution of NaCl is added to an aqueous solution containing the complex ion  $\text{Fe}(\text{H}_2\text{O})_6^{3+}$  and an equilibrium is established:

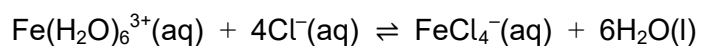

The concentration of  $\text{Cl}^-$  in the equilibrium mixture is  $2.0 \text{ mol dm}^{-3}$ .

The numerical value of the equilibrium constant,  $K_c$ , is 0.05.

The expression for  $K_c$  does not include the solvent.

What is the ratio of the concentrations  $[\text{FeCl}_4^-] : [\text{Fe}(\text{H}_2\text{O})_6^{3+}]$  in the equilibrium mixture?

(All concentrations are in  $\text{mol dm}^{-3}$ .)

- A 4:5
- B 5:4
- C 1:10
- D 10:1
- E 1:320
- F 320:1

- 25 When organic compounds are treated with an alkaline aqueous solution of iodine, a yellow precipitate is formed by those compounds that contain either of these structural fragments:

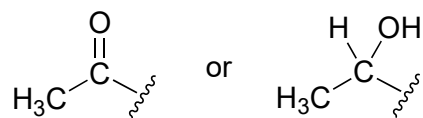

There are 8 structurally isomeric alcohols with the molecular formula  $\text{C}_5\text{H}_{12}\text{O}$ .

Each of these alcohols was heated under reflux with excess acidified potassium dichromate(VI).

How many of these alcohols gave a product that would form a yellow precipitate with an alkaline aqueous solution of iodine?

- A 1
- B 2
- C 3
- D 4
- E 5
- F 6
- G 7

- 26** Calcium cyanamide is a compound containing calcium, carbon and nitrogen only. It contains 50% calcium by mass, and reacts with water to form ammonia and one other product that does not contain nitrogen or hydrogen.

One mole of calcium cyanamide contains one mole of calcium.

What volume of water, in  $\text{cm}^3$ , is required to react exactly with 8.0 g of calcium cyanamide?

( $A_r$  values: H = 1; C = 12; N = 14; O = 16; Ca = 40. Density of water is  $1.0 \text{ g cm}^{-3}$ .)

- A**  $1.8 \text{ cm}^3$
- B**  $2.7 \text{ cm}^3$
- C**  $3.6 \text{ cm}^3$
- D**  $5.4 \text{ cm}^3$
- E**  $18 \text{ cm}^3$
- F**  $27 \text{ cm}^3$
- G**  $36 \text{ cm}^3$
- H**  $54 \text{ cm}^3$

- 27  $\Delta G$  (Gibbs free energy change),  $\Delta H$  (enthalpy change) and  $\Delta S$  (entropy change) are thermodynamic quantities for a reaction linked by the equation

$$\Delta G = \Delta H - T\Delta S$$

where  $T$  = temperature measured in kelvin (K).

The graph shows how  $\Delta G$ , in  $\text{kJ mol}^{-1}$ , varies with temperature, in K, for a reaction at constant pressure.

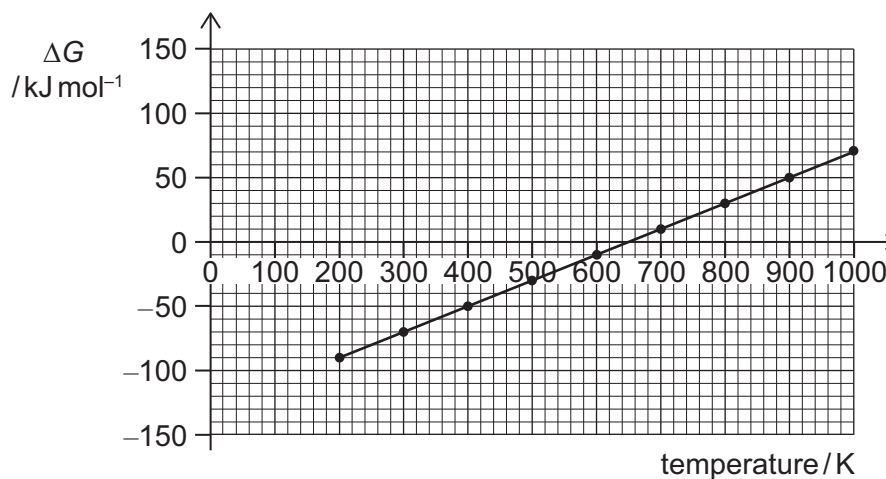

Is the reaction endothermic or exothermic, and what is the value of  $\Delta S$ , in  $\text{J mol}^{-1} \text{K}^{-1}$ ?

(Assume that  $\Delta H$  and  $\Delta S$  do not vary with temperature over this range.)

	<i>the reaction is...</i>	$\Delta S / \text{J mol}^{-1} \text{K}^{-1}$
<b>A</b>	endothermic	-0.20
<b>B</b>	endothermic	+0.20
<b>C</b>	endothermic	-200
<b>D</b>	endothermic	+200
<b>E</b>	exothermic	-0.20
<b>F</b>	exothermic	+0.20
<b>G</b>	exothermic	-200
<b>H</b>	exothermic	+200

- 28 The table gives information relating to the enthalpy change of formation of calcium chloride.

	<i>enthalpy change</i> /kJ mol <sup>-1</sup>
Ca(s) → Ca(g)	+190
Ca(g) → Ca <sup>+</sup> (g) + e <sup>-</sup>	+590
Ca <sup>+</sup> (g) → Ca <sup>2+</sup> (g) + e <sup>-</sup>	+1150
Cl <sub>2</sub> (g) → 2Cl(g)	+240
Cl(g) + e <sup>-</sup> → Cl <sup>-</sup> (g)	-360
CaCl <sub>2</sub> (s) → Ca <sup>2+</sup> (g) + 2Cl <sup>-</sup> (g)	+2240

Using the data provided, what is the enthalpy change of formation of calcium chloride?

- A +650 kJ mol<sup>-1</sup>
- B -430 kJ mol<sup>-1</sup>
- C -790 kJ mol<sup>-1</sup>
- D -910 kJ mol<sup>-1</sup>
- E -980 kJ mol<sup>-1</sup>
- F -1270 kJ mol<sup>-1</sup>
- G -1380 kJ mol<sup>-1</sup>
- H -1700 kJ mol<sup>-1</sup>

- 29** Copper metal reacts with aqueous iron(III) ions to form aqueous iron(II) ions and aqueous copper(II) ions.

Which of the following statements can be deduced about this reaction?

- A** Copper(II) ions are a stronger reducing agent than iron(II) ions.
- B** Copper(II) ions are a stronger oxidising agent than iron(III) ions.
- C** Iron(II) ions are a stronger reducing agent than copper metal.
- D** Copper metal is a stronger oxidising agent than iron(II) ions.
- E** Iron(III) ions are a stronger oxidising agent than copper(II) ions.

- 30** Heat loss is a problem in calorimetry experiments and can lead to inaccurate results. One way to address this problem is to carry out an experiment to find the heat capacity of the calorimeter (for example, 100 g of water in a copper can) using a reaction where the molar enthalpy change is known.

A student burned  $m^{(\text{ethanol})}$  grams of ethanol (relative molar mass =  $M_r^{(\text{ethanol})}$ ) in a burner and the temperature of the water in the calorimeter rose by  $\Delta T^{(\text{ethanol})}$  in  $^{\circ}\text{C}$ . The molar enthalpy of combustion of ethanol is  $\Delta H^{(\text{ethanol})}$ .

The student then burned  $m^{(\text{propanol})}$  grams of propanol (relative molar mass =  $M_r^{(\text{propanol})}$ ) in the burner using the same calorimeter and the temperature of the water rose by  $\Delta T^{(\text{propanol})}$  in  $^{\circ}\text{C}$ .

Which expression gives the molar enthalpy of combustion of propanol  $\Delta H^{(\text{propanol})}$ ?

(All other conditions for these experiments were identical.)

- A**  $\Delta H^{(\text{ethanol})} \times \frac{\Delta T^{(\text{ethanol})} \times M_r^{(\text{propanol})} \times m^{(\text{ethanol})}}{\Delta T^{(\text{propanol})} \times M_r^{(\text{ethanol})} \times m^{(\text{propanol})}}$
- B**  $\Delta H^{(\text{ethanol})} \times \frac{\Delta T^{(\text{ethanol})} \times M_r^{(\text{ethanol})} \times m^{(\text{ethanol})}}{\Delta T^{(\text{propanol})} \times M_r^{(\text{propanol})} \times m^{(\text{propanol})}}$
- C**  $\Delta H^{(\text{ethanol})} \times \frac{\Delta T^{(\text{ethanol})} \times M_r^{(\text{ethanol})} \times m^{(\text{propanol})}}{\Delta T^{(\text{propanol})} \times M_r^{(\text{propanol})} \times m^{(\text{ethanol})}}$
- D**  $\Delta H^{(\text{ethanol})} \times \frac{\Delta T^{(\text{propanol})} \times M_r^{(\text{ethanol})} \times m^{(\text{ethanol})}}{\Delta T^{(\text{ethanol})} \times M_r^{(\text{propanol})} \times m^{(\text{propanol})}}$
- E**  $\Delta H^{(\text{ethanol})} \times \frac{\Delta T^{(\text{propanol})} \times M_r^{(\text{ethanol})} \times m^{(\text{propanol})}}{\Delta T^{(\text{ethanol})} \times M_r^{(\text{propanol})} \times m^{(\text{ethanol})}}$
- F**  $\Delta H^{(\text{ethanol})} \times \frac{\Delta T^{(\text{propanol})} \times M_r^{(\text{propanol})} \times m^{(\text{ethanol})}}{\Delta T^{(\text{ethanol})} \times M_r^{(\text{ethanol})} \times m^{(\text{propanol})}}$

- 31** In an experiment to investigate diffusion, four separate identical flasks containing one of hydrogen, helium, nitrogen or neon are placed in a large cubic box filled with argon, each in a different corner. All gases, including the argon, are at atmospheric pressure.

The temperature of the box is uniform and remains constant throughout the experiment. Temperature is directly proportional to the average kinetic energy of the particles in a gas.

The stoppers of the flasks are removed simultaneously and the time is recorded when a fixed proportion of each gas reaches a detector at the centre of the box.

A second experiment is carried out under the same conditions but at a higher temperature.

( $A_r$  values: H = 1.0; He = 4.0; N = 14; Ne = 20)

Which statement is correct?

- A** If hydrogen is detected in  $t$  minutes, then helium will be detected in  $\sqrt{2}t$  minutes.
- B** The kinetic energy of every gas particle in the box will be the same at the same room temperature.
- C** The order in which the gases are detected at both temperatures is hydrogen, then helium, then nitrogen, and lastly neon.
- D** The average speed at which a helium particle travels is 5 times the speed at which an average neon particle travels.
- E** When the temperature of the box is increased, the average kinetic energy of the gases will decrease.



- 32 A high temperature reaction vessel requires a steady supply of an atmosphere free of oxygen, carbon monoxide and  $\text{NO}_x$  gases.

In order to achieve this, methane was burned in air to give a mixture of carbon dioxide, water vapour and nitrogen only.

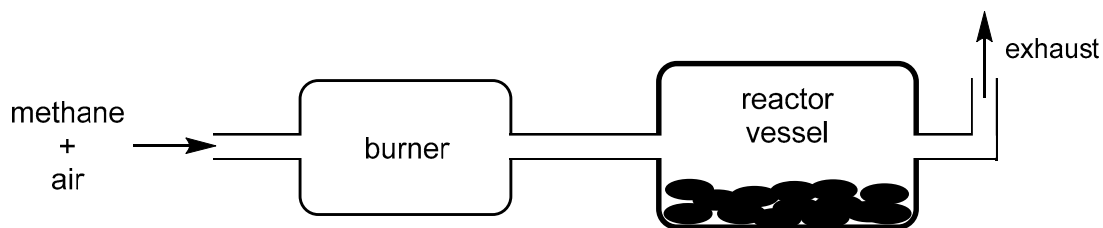

Assume that air is composed of 20% oxygen and 80% nitrogen only by volume.

What **mass** ratio of air to methane should be supplied to the burner?

( $A_r$  values: H = 1; C = 12; N = 14; O = 16. Assume that one mole of any gas occupies the same volume at a given temperature and pressure.)

- A 2:1
- B 2.5:1
- C 4.5:1
- D 5:1
- E 9:1
- F 18:1
- G 20:1

- 33** In preparation for the disposal of  $500\text{ cm}^3$  of  $4\text{ mol dm}^{-3}$  hydrochloric acid with a pH value of  $-0.6$  (minus 0.6) into a drain, the following steps were taken:

*step 1* The acid was diluted with  $100\text{ dm}^3$  water.

*step 2* 90 g of calcium carbonate powder was added which completely reacted.

*step 3* The resulting solution was diluted with water to give a final volume of  $500\text{ dm}^3$ .

What is the final pH value of the solution?

( $M_r$  value:  $\text{CaCO}_3 = 100$ . All pH values were measured at the same temperature.)

- A** 2.9
- B** 3.4
- C** 3.6
- D** 4.4
- E** 4.6
- F** 5.4
- G** 6.0
- H** 7.0

- 34** Lutetium (Lu) is a metallic element which forms compounds in which lutetium always has the same oxidation state.

When 3.50 g of lutetium is heated and burned in excess oxygen, 360 cm<sup>3</sup> of oxygen, measured at room temperature and pressure, is needed for complete reaction to form lutetium oxide.

When 3.50 g of lutetium reacts completely with dilute sulfuric acid, hydrogen and aqueous lutetium sulfate are produced. The salt is extracted from solution and allowed to crystallise into a white solid.

The solid is a hydrated salt with a 1 : 1 molar ratio of water to salt.

What is the maximum mass of hydrated salt that could be made from 3.50 g of lutetium?

( $A_r$  values: Lu = 175; S = 32; O = 16; H = 1. Assume that one mole of any gas occupies 24 dm<sup>3</sup> at room temperature and pressure.)

- A** 5.42 g
- B** 5.78 g
- C** 6.38 g
- D** 6.56 g
- E** 9.26 g
- F** 9.62 g
- G** 12.76 g
- H** 13.12 g

- 35 Sodium feredetate trihydrate and iron(II) sulfate can both be used to treat iron deficiency.

The formula for sodium feredetate trihydrate is:

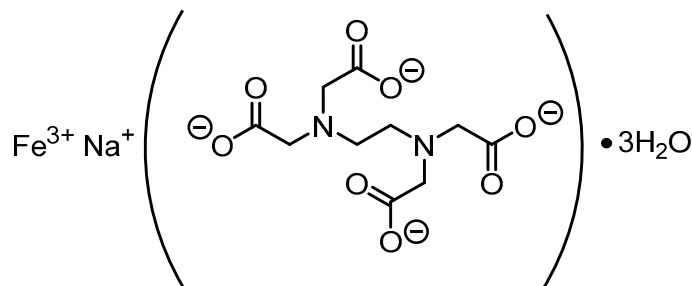

Sodium feredetate trihydrate is used as a solution.  $5.00 \text{ cm}^3$  of this solution contains  $210.5 \text{ mg}$  of sodium feredetate trihydrate.

Iron(II) sulfate is used in tablet form. One iron tablet contains  $63.0 \text{ mg}$  of iron(II) ions.

What volume of sodium feredetate trihydrate solution would give the same mass of iron as one iron(II) sulfate tablet?

( $A_r$  values: H = 1.0; C = 12; N = 14; O = 16; Na = 23; Fe = 56)

- A  $0.450 \text{ cm}^3$
- B  $2.25 \text{ cm}^3$
- C  $9.81 \text{ cm}^3$
- D  $10.29 \text{ cm}^3$
- E  $10.93 \text{ cm}^3$
- F  $11.25 \text{ cm}^3$

- 36** Three half-equations involved in the oxidation of ethanol to ethanoic acid are:

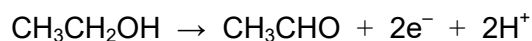
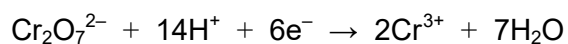

A flask contains 0.345 g of ethanol. An excess of dilute sulfuric acid is added to the flask.

A separate flask contains 0.200 mol dm<sup>-3</sup> aqueous dichromate ions, Cr<sub>2</sub>O<sub>7</sub><sup>2-</sup>.

What volume of aqueous dichromate is needed to exactly convert all the ethanol to ethanoic acid?

(*M<sub>r</sub>* value: CH<sub>3</sub>CH<sub>2</sub>OH = 46)

- A** 6.25 cm<sup>3</sup>
- B** 9.38 cm<sup>3</sup>
- C** 12.50 cm<sup>3</sup>
- D** 25.00 cm<sup>3</sup>
- E** 37.50 cm<sup>3</sup>
- F** 56.25 cm<sup>3</sup>
- G** 112.50 cm<sup>3</sup>

- 37** V is a compound with empirical formula  $\text{CH}_2$ . It undergoes an addition reaction with hydrogen bromide, producing compound W.

W reacts with potassium cyanide to produce organic compound X which contains approximately  $\frac{1}{6}$  by mass of nitrogen.

W also reacts with warm aqueous sodium hydroxide to give organic compound Y.

Y reacts with hot acidified potassium dichromate(VI) to produce organic compound Z.

Z does not react with aqueous sodium carbonate, nor does it react with Tollens' reagent.

Which of the following is a possible identity for W?

( $A_r$  values: H = 1; C = 12; N = 14)

- A** 1-bromobutane
- B** 1-bromopentane
- C** 1-bromopropane
- D** 2-bromo-2-methylpropane
- E** 2-bromobutane
- F** 2-bromo-2-methylbutane
- G** 2-bromopropane
- H** 3-bromopentane

- 38** A student is planning an experiment to determine the percentage of iron in a 3 g sample of the iron ore haematite, which contains  $\text{Fe}_2\text{O}_3$  as the only iron-containing species and other material which will not react in this experiment. The sample contains approximately 50% iron by mass.

The student's plan is:

- step 1* Make a solution of  $\text{Fe}^{3+}$  ions by reacting iron(III) oxide with concentrated acid.
- step 2* Reduce the  $\text{Fe}^{3+}$  ions to  $\text{Fe}^{2+}$  ions using a solution of tin(II) chloride.
- step 3* Make up the solution containing  $\text{Fe}^{2+}$  to  $250\text{ cm}^3$  by adding water.
- step 4* Titrate  $25\text{ cm}^3$  portions using potassium dichromate(VI) solution,  $\text{K}_2\text{Cr}_2\text{O}_7$ .

The equations for the reactions occurring are:

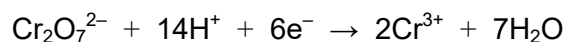
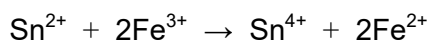
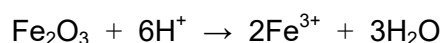

In order to obtain titre values of between  $15\text{ cm}^3$  and  $35\text{ cm}^3$ , what concentration of potassium dichromate(VI), in  $\text{mol dm}^{-3}$ , should the student use?

( $A_r$  value: Fe = 56)

- A**  $0.02\text{ mol dm}^{-3}$
- B**  $0.04\text{ mol dm}^{-3}$
- C**  $0.10\text{ mol dm}^{-3}$
- D**  $0.20\text{ mol dm}^{-3}$
- E**  $0.50\text{ mol dm}^{-3}$
- F**  $1.00\text{ mol dm}^{-3}$

- 39** 0.92 g of gaseous dinitrogen tetroxide,  $\text{N}_2\text{O}_4(\text{g})$ , is placed in a syringe with a free moving piston at  $25^\circ\text{C}$  and atmospheric pressure.

At  $25^\circ\text{C}$ , gaseous dinitrogen tetroxide dissociates and forms an equilibrium mixture with gaseous nitrogen dioxide,  $\text{NO}_2(\text{g})$ , only.

At equilibrium, the total volume of gas in the syringe is  $288\text{ cm}^3$ .

What percentage of the dinitrogen tetroxide has dissociated?

( $A_r$  values:  $\text{N} = 14$ ;  $\text{O} = 16$ . Assume that, for all of the gases, one mole of gas occupies a volume of  $24\text{ dm}^3$  at  $25^\circ\text{C}$  and atmospheric pressure.)

- A** 10%
- B** 20%
- C** 30%
- D** 40%
- E** 50%
- F** 60%
- G** 70%
- H** 80%



- 40** Fluoride ions can be added to drinking water to improve dental health.

The recommended concentration of fluoride ions in drinking water for observable health benefits is between 1.0 and 1.5 ppm by mass.

The concentration of fluoride ions in a full 10 million litre water storage reservoir is 0.5 ppm.

The following three compounds can be used to supply fluoride ions to water:

sodium fluoride ( $\text{NaF}$ ,  $M_r = 42$ )

hexafluorosilicic acid ( $\text{H}_2\text{SiF}_6$ ,  $M_r = 144$ )

sodium fluorosilicate ( $\text{Na}_2\text{SiF}_6$ ,  $M_r = 188$ )

Assume that all the fluorine present in the compounds ionises in water to form fluoride ions.

Which of the following treatments can be added to increase the fluoride ion concentration to within the recommended range?

( $A_r$  value:  $\text{F} = 19$ . Density of water is  $1 \text{ g cm}^{-3}$ .  $1 \text{ ppm} = 1 \text{ part per million} = 0.0001\%$ .)

- A** 6.30 kg of sodium fluoride ( $\text{NaF}$ )
- B** 7200 g of hexafluorosilicic acid ( $\text{H}_2\text{SiF}_6$ )
- C** 14 400 g of hexafluorosilicic acid ( $\text{H}_2\text{SiF}_6$ )
- D** 18.8 g of sodium fluorosilicate ( $\text{Na}_2\text{SiF}_6$ )
- E** 37.6 kg of sodium fluorosilicate ( $\text{Na}_2\text{SiF}_6$ )

**BLANK PAGE**

## **PART Z Biology**

- 41** A solution containing sucrose, starch and amylase was incubated at 37 °C. After the reactions had completed, the student divided the solution into three test tubes and carried out the following tests:

- add biuret reagent
- add iodine solution
- add Benedict's solution and heat

Which row shows the final colours after the tests?

	<i>add biuret reagent</i>	<i>add iodine solution</i>	<i>add Benedict's solution and heat</i>
<b>A</b>	purple	yellow-brown	blue
<b>B</b>	purple	blue-black	red
<b>C</b>	purple	yellow-brown	red
<b>D</b>	purple	blue-black	blue
<b>E</b>	blue	yellow-brown	blue
<b>F</b>	blue	blue-black	red
<b>G</b>	blue	yellow-brown	red
<b>H</b>	blue	blue-black	blue

**42** A sample of blood was taken from a healthy human.

There were  $5 \times 10^9$  red blood cells in  $1 \text{ cm}^3$  of the blood.

The ratio of the volume of red blood cells to other blood components was 2 : 3.

Which of the following statements is/are correct?

- 1** The genetic material of a mature red blood cell is contained in its nucleus.
  - 2** The mean volume of a red blood cell is  $8 \times 10^{-8} \text{ mm}^3$ .
  - 3** Human red blood cells have a higher surface area to volume ratio compared to a spherical cell of the same volume.
- A** none of them
- B** 1 only
- C** 2 only
- D** 3 only
- E** 1 and 2 only
- F** 1 and 3 only
- G** 2 and 3 only
- H** 1, 2 and 3

- 43 An enzyme called EcoRI is used to cut out a gene from the middle of a human chromosome. This process produces sticky ends as shown in the diagram.

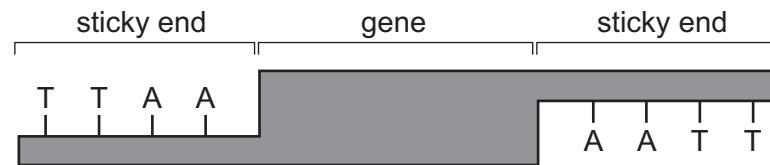

When guanine separates from its complementary base, three hydrogen bonds are broken, whereas two are broken when the other pair of bases separate.

Which row is correct?

	<i>EcoRI</i> is a	<i>the number of base-pairing hydrogen bonds broken when this gene was cut out using EcoRI</i>
<b>A</b>	restriction enzyme	16
<b>B</b>	restriction enzyme	20
<b>C</b>	restriction enzyme	24
<b>D</b>	ligase	16
<b>E</b>	ligase	20
<b>F</b>	ligase	24

- 44** A student studied the effect of different colours of light on photosynthesis by algae. Large numbers of algal cells were trapped inside balls of a clear jelly-like substance. The average diameter of the algal balls was 5 mm.

These balls were then placed in a test tube filled with a solution. The solution contained substances necessary for photosynthesis by the algal cells, and had a pH of 7.8. The whole test tube was then wrapped in a coloured filter and left in bright light for two hours. All other factors were kept constant.

After two hours the pH of each solution was measured. The results are shown in the table.

<i>colour of filter</i>	<i>pH of solution after two hours</i>
blue	8.3
green	7.5
red	8.6
colourless	9.3
black	7.1

The volume of a sphere is  $\frac{4}{3}\pi r^3$ , where  $r$  is the radius.

Which of the following statements is/are correct?

- 1** The average volume of one of the algal balls is  $\frac{1}{6}\pi \text{ cm}^3$ .
  - 2** In only the test tubes with red, blue and colourless filters, the increase in pH can be explained by an increase in the amount of carbon dioxide released by the algal balls.
  - 3** Conducting these experiments at a higher temperature could increase the rate of change in pH in all the tubes.
- A** none of them
- B** 1 only
- C** 2 only
- D** 3 only
- E** 1 and 2 only
- F** 1 and 3 only
- G** 2 and 3 only
- H** 1, 2 and 3

- 45** In a test to compare the function of the human respiratory system in different individuals, they were asked to breathe out as hard as possible for as long as possible. The volume exhaled was recorded.

The graph shows the results obtained after carrying out this test on two males with the same height and body mass.

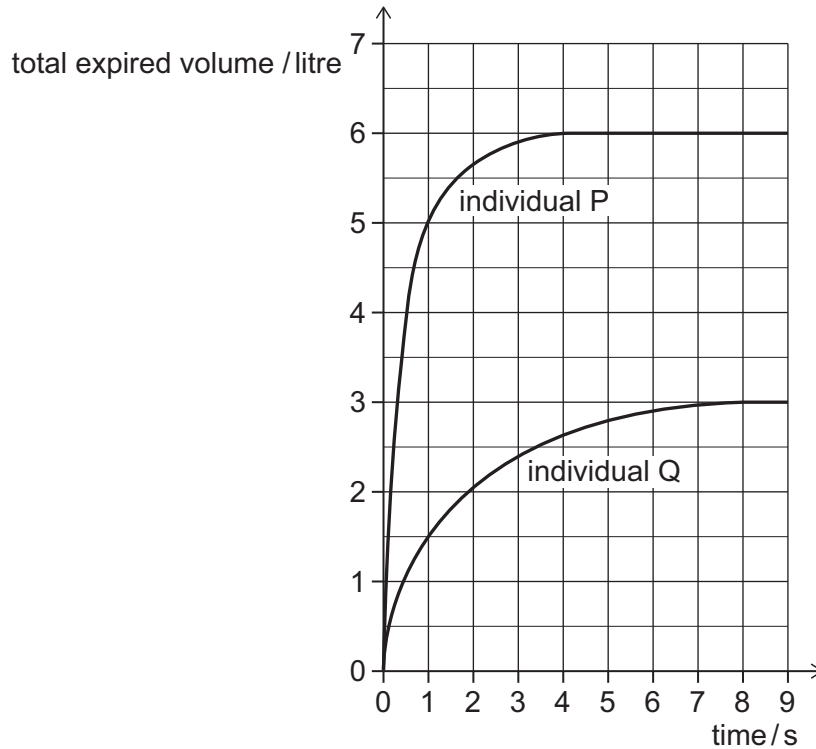

Which of the following statements is/are correct?

- 1 Individual P exhaled 200% more than individual Q.
  - 2 Individual Q's diaphragm was more domed at 7 seconds than at 2 seconds.
  - 3 The mean rate of air flow in the first second was 233% more in individual P than in individual Q (to the nearest whole percentage).
- A** none of them  
**B** 1 only  
**C** 2 only  
**D** 3 only  
**E** 1 and 2 only  
**F** 1 and 3 only  
**G** 2 and 3 only  
**H** 1, 2 and 3



- 46 The graph shows the mass of antibody produced by antibody-producing cells over a period of 20 hours.

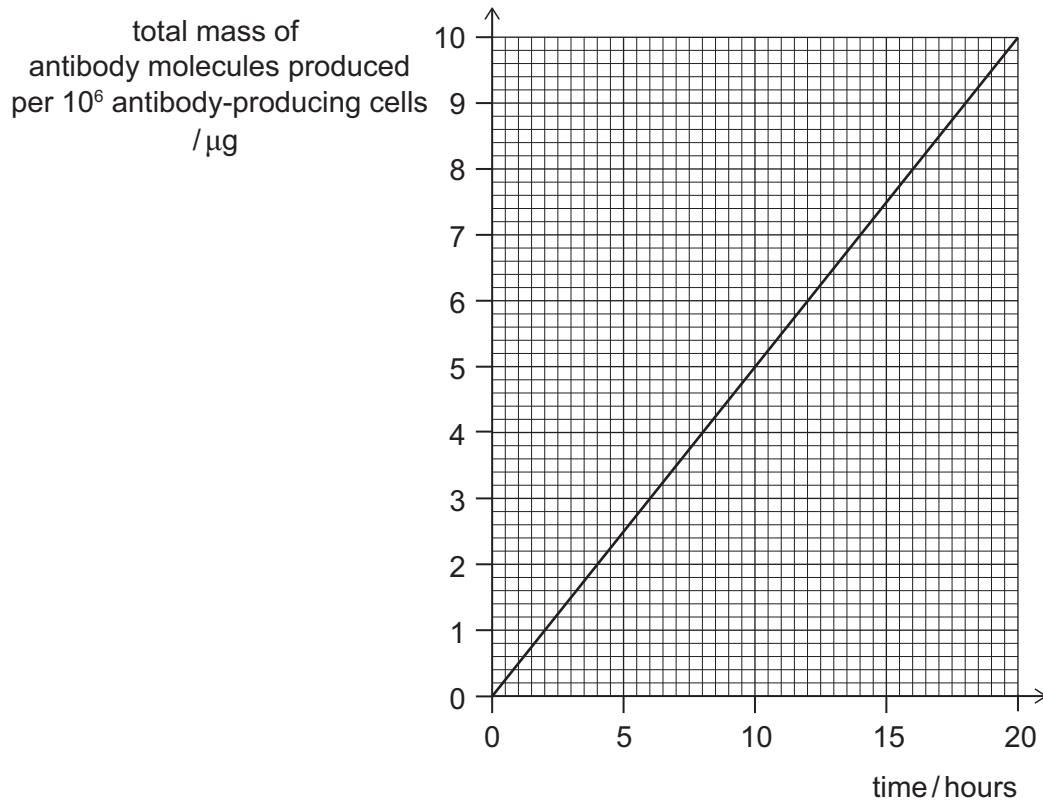

Assume that one antibody molecule has a mass of  $2.5 \times 10^{-19}$  g.

Which of the following statements is/are correct?

- 1 One antibody-producing cell produces  $2 \times 10^6$  antibody molecules per hour.
  - 2 Antibodies are produced in response to dead and living pathogens.
  - 3 Phagocytes produce antibodies.
- A** none of them
- B** 1 only
- C** 2 only
- D** 3 only
- E** 1 and 2 only
- F** 1 and 3 only
- G** 2 and 3 only
- H** 1, 2 and 3

47 The table identifies various values relating to microscopy.

Which row in the table is correct?

	<i>the maximum useful magnification of a light microscope</i>	<i>the resolution limit of a transmission electron microscope</i>	<i>the actual diameter of an adenovirus pathogen based on a <math>1 \times 10^6</math> magnified image with a diameter of 20 mm</i>
<b>A</b>	×150	0.2 nm	20 nm
<b>B</b>	×150	0.2 nm	20 μm
<b>C</b>	×150	200 nm	20 nm
<b>D</b>	×150	200 nm	200 nm
<b>E</b>	×1500	0.2 nm	20 nm
<b>F</b>	×1500	0.2 nm	200 nm
<b>G</b>	×1500	200 nm	20 μm
<b>H</b>	×1500	200 nm	200 nm

- 48** Complete ribosomes are made from one large subunit and one small subunit joined together. The subunit names are based on their sizes as shown in the table.

<i>size of ribosomal subunit</i>	<i>name of subunit in eukaryotes</i>	<i>name of subunit in prokaryotes</i>
small	40S	30S
large	60S	50S

In a study, scientists found that one organism made and assembled the subunits in its nucleus. The complete ribosome was then transported to the cytoplasm.

Which row is correct?

	<i>name of the large subunit in the complete ribosome studied</i>	<i>components found in the ribosomal subunits</i>
<b>A</b>	50S	amino acids and no nucleotide bases
<b>B</b>	50S	adenine, cytosine, guanine, thymine
<b>C</b>	50S	amino acids, adenine, cytosine, guanine, thymine
<b>D</b>	50S	amino acids, adenine, cytosine, guanine, uracil
<b>E</b>	60S	amino acids and no nucleotide bases
<b>F</b>	60S	adenine, cytosine, guanine, thymine
<b>G</b>	60S	amino acids, adenine, cytosine, guanine, thymine
<b>H</b>	60S	amino acids, adenine, cytosine, guanine, uracil

- 49 Some varieties of plant crops, like maize, can survive at low temperatures, such as 4 °C.

Scientists identified protein Z that they believe to be involved in the response to low temperatures in maize.

One method of studying how plants survive at low temperatures is to investigate the levels of ion leakage from cells damaged by the low temperatures. Higher levels of ion leakage are associated with lower levels of survival.

The scientists measured the levels of ions leaking from cells of three varieties of maize.

<i>variety of maize</i>	<i>description</i>
P	normal maize plant
Q	contains a single base pair insertion in the DNA near the start of the gene coding for protein Z
R	is genetically modified to produce the highest levels of protein Z

Other than the changes listed in the table, the plants were genetically identical.

Ion leakage from samples of cells of each variety was measured after the plants had been kept at 4 °C for 4 days. All other variables were kept constant.

The results of this investigation are shown in the chart.

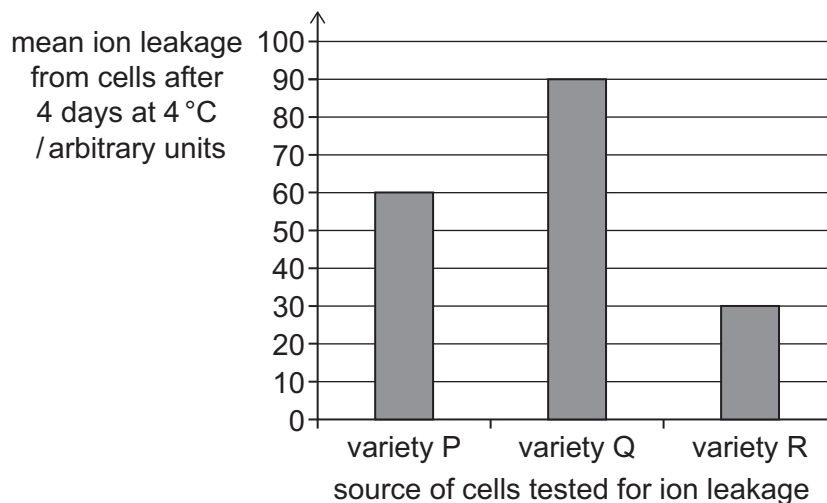

**49** Which of the following statements is/are correct?

- 1** The cell wall in maize cells controls the leakage of ions from the cell at 4 °C.
  - 2** Inserting an extra base pair near the start of the gene for protein Z could change the overall amino acid sequence of the protein.
  - 3** The presence of protein Z in maize cells increases the chance of the maize plant surviving at 4 °C.
- A** none of them
- B** 1 only
- C** 2 only
- D** 3 only
- E** 1 and 2 only
- F** 1 and 3 only
- G** 2 and 3 only
- H** 1, 2 and 3

- 50** Some bacteria become resistant to antibiotics due to the loss of the proteins in their cell surface membranes that the antibiotic uses to enter the cell. To overcome this problem, scientists have developed nanomachines that can make holes in these membranes, allowing the antibiotic to enter and destroy the bacteria.

Scientists studied the effects of these nanomachines in two antibiotic-resistant strains of bacteria, R and S. Each culture started with  $2.5 \times 10^6$  living cells. They carried out two sets of experiments, one without the nanomachines and one with the nanomachines. The results are shown in the chart.

All other factors were kept the same.

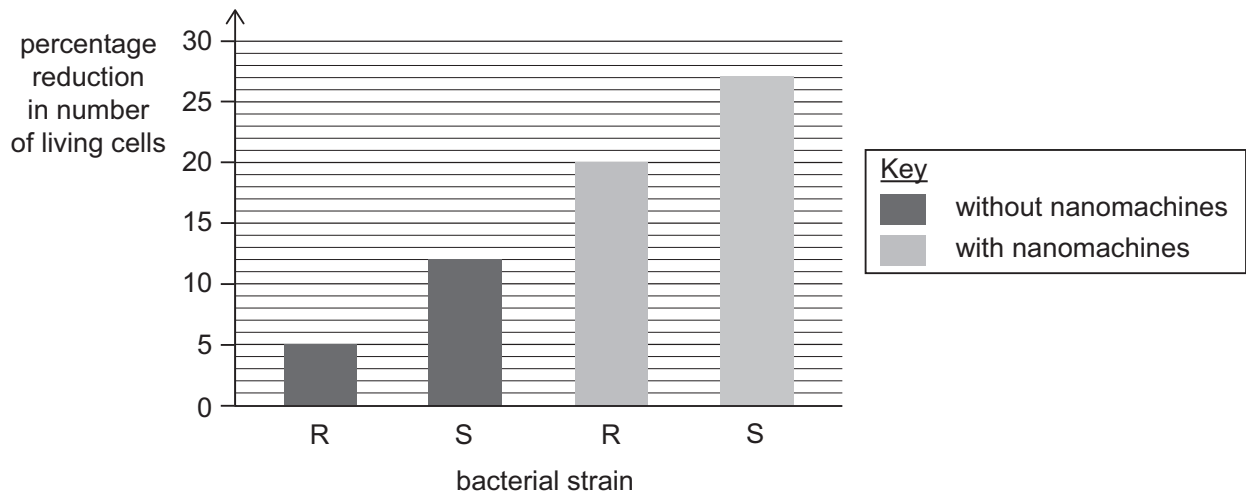

Which of the following statements is/are correct?

- 1 The number of living cells of strain S in the experiment with the nanomachines is 2.25 times higher than in the experiment without the nanomachines.
  - 2 The cells of strain S may have more proteins in their cell membranes than strain R, which allow the antibiotic to enter their cells.
  - 3 There would be  $2 \times 10^6$  living cells of strain R at the end of the experiment with the nanomachines.
- A** none of them
- B** 1 only
- C** 2 only
- D** 3 only
- E** 1 and 2 only
- F** 1 and 3 only
- G** 2 and 3 only
- H** 1, 2 and 3

51 Some chemotherapy drugs interfere with the mitotic cell cycle.

The following table lists five chemotherapy drugs and their mechanisms of action.

<i>chemotherapy drug</i>	<i>mechanism of action</i>
Dinaciclib	prevents cells progressing beyond prophase
Doxorubicin	prevents DNA repair following incorrect DNA replication
Methotrexate	inhibits enzymes responsible for DNA synthesis
Vinblastine	inhibits spindle fibre assembly
Wiskostatin	inhibits cytokinesis

The following diagram shows a simplified version of the mitotic cell cycle.

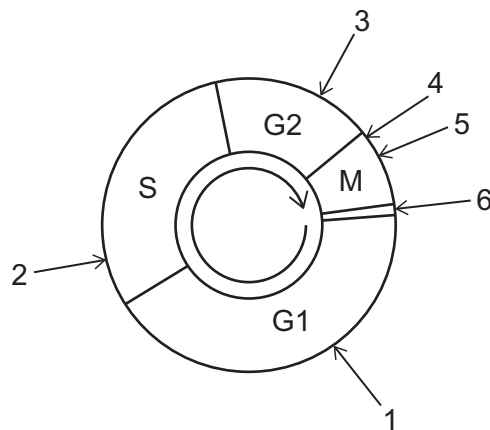

Which row identifies the position on the diagram where each chemotherapy drug is most likely to act?

	<i>Dinaciclib</i>	<i>Doxorubicin</i>	<i>Methotrexate</i>	<i>Vinblastine</i>	<i>Wiskostatin</i>
<b>A</b>	4	3	1	6	5
<b>B</b>	3	2	4	5	6
<b>C</b>	5	2	3	6	4
<b>D</b>	4	3	2	5	6
<b>E</b>	3	4	2	1	5
<b>F</b>	3	2	4	1	5
<b>G</b>	4	5	2	3	6

52 The properties of three biological membranes were investigated. It was found that:

- There is a positive correlation between the fluidity of a membrane and the rate of simple diffusion of substance X across it.
- Cholesterol increases the fluidity of membranes at low temperatures, but decreases their fluidity at high temperatures.
- The cell surface membrane has the highest percentage of cholesterol, and the lysosomal membrane has the second highest percentage of cholesterol.

Which of the following sketch graphs is consistent with this information?

**Key**

- ..... Golgi apparatus membrane  
 - - - - - inner mitochondrial membrane  
 ——— cell surface membrane

**A** permeability to substance X

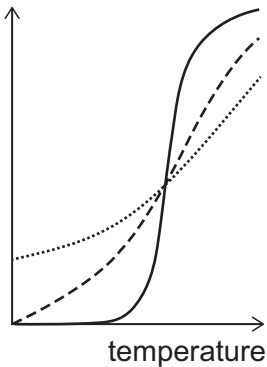

**B** permeability to substance X

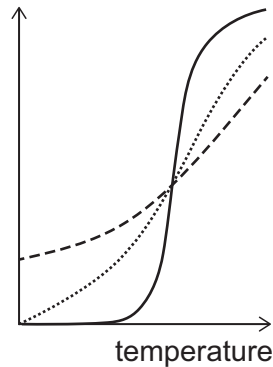

**C** permeability to substance X

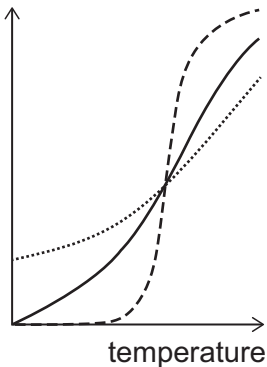

**D** permeability to substance X

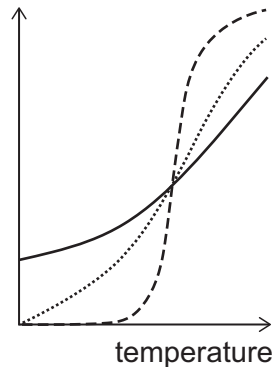

**E** permeability to substance X

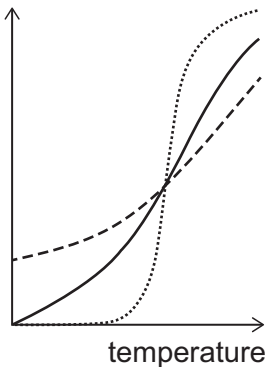

**F** permeability to substance X

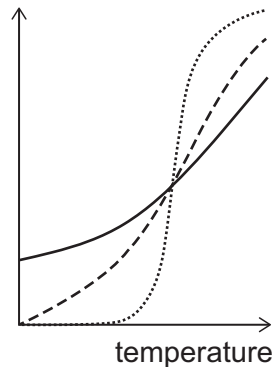



- 53 A 0.2 cm long section of xylem, with internal diameter 60  $\mu\text{m}$ , was studied.

The velocity at which substances were transported through the xylem in a plant was found to be 3.6 metres per hour in the morning. Later in the day the velocity was greater.

Which row of the table is correct?

	<i>velocity of substance transport in the morning / <math>\mu\text{m s}^{-1}</math></i>	<i>internal volume of the xylem section / <math>\mu\text{m}^3</math></i>	<i>environmental factor that could have resulted in change in velocity later in the day</i>
<b>A</b>	0.001	$180\pi$	increased sunlight
<b>B</b>	0.001	$720\pi$	increased humidity
<b>C</b>	0.001	$1\,800\,000\pi$	increased humidity
<b>D</b>	1000	$180\pi$	increased wind speed
<b>E</b>	1000	$1\,800\,000\pi$	increased sunlight
<b>F</b>	1000	$7\,200\,000\pi$	increased humidity
<b>G</b>	3600000	$720\pi$	increased wind speed
<b>H</b>	3600000	$7\,200\,000\pi$	increased sunlight

- 54** In cold conditions mice maintain their core body temperature by increased heat production.

The graph shows the effect of environmental temperature on oxygen consumption by one strain of mouse.

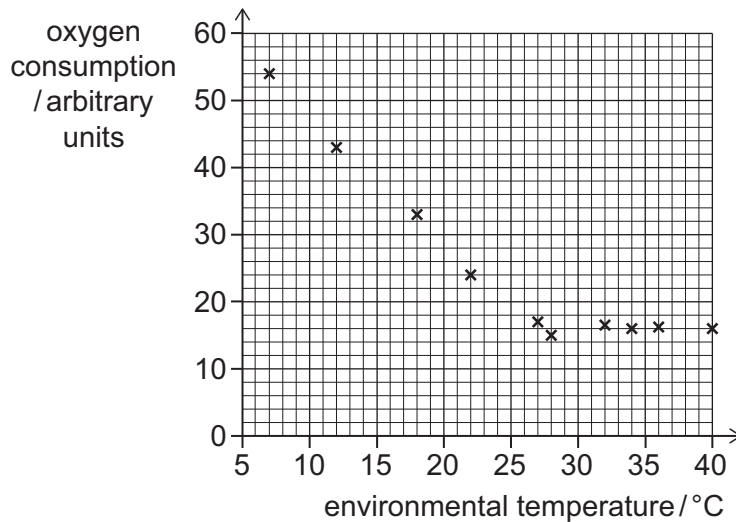

Mice of the same strain have been produced with a mutation that results in a thinner and less insulating layer of fat in their skin.

Which of the following statements is/are correct?

- 1** The homeostatic control of core body temperature only occurs in environmental temperatures between 28 °C and 40 °C.
  - 2** Between 12 °C and 18 °C, each 1 °C increase in temperature decreases the mean oxygen consumption by  $1\frac{2}{3}$  arbitrary units.
  - 3** Between 10 °C and 20 °C, the change in oxygen consumption for the mice with the mutation will decrease more than for the non-mutated mice.
- A** none of them
- B** 1 only
- C** 2 only
- D** 3 only
- E** 1 and 2 only
- F** 1 and 3 only
- G** 2 and 3 only
- H** 1, 2 and 3

**55** A scientist studied the aorta, a renal artery and a capillary in a healthy human.

The scientist measured the radii of two of the vessels, P and Q, and made a drawing of the third, R.

- P: lumen radius =  $2.5 \times 10^{-3}$  m
- Q: lumen radius = 8000  $\mu$ m
- R: at magnification  $\times 5000$ , diameter of lumen in drawing = 4.5 cm

Which row identifies the three blood vessels?

	<i>vessel P</i>	<i>vessel Q</i>	<i>vessel R</i>
<b>A</b>	aorta	capillary	renal artery
<b>B</b>	aorta	renal artery	capillary
<b>C</b>	capillary	aorta	renal artery
<b>D</b>	capillary	renal artery	aorta
<b>E</b>	renal artery	aorta	capillary
<b>F</b>	renal artery	capillary	aorta

- 56** A student investigated the effect of increasing the size of an agar (a jelly-like substance) cube on its efficiency to absorb and distribute a blue dye.

Two agar cubes were prepared, one with side lengths of 1 cm and the other with side lengths of 3 cm. They were put in a solution of blue dye for 30 minutes.

The cubes were then removed from the dye and cut in half to measure the penetration of the dye into the agar.

In the 3 cm cube the dye had penetrated to a depth of 0.75 cm. The cross section of this cube is shown:

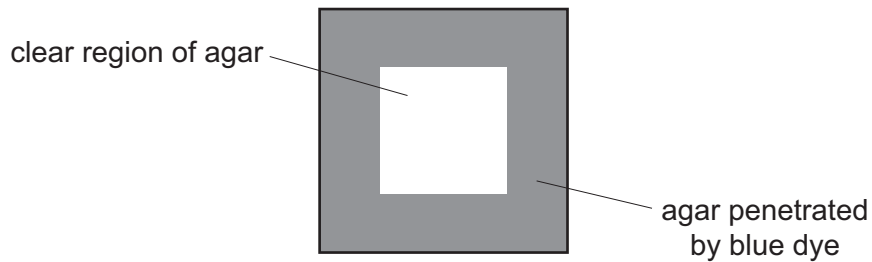

[diagram not to scale]

When the cube with sides of 1 cm was cut in half, all the agar had been penetrated with the dye.

Which row is correct for this investigation?

	<i>percentage of the volume of the 3 cm cube penetrated by the dye</i>	<i>change in surface area : volume ratio as cube size increases</i>	<i>process(es) to describe the movement of the blue dye into the cube</i>
<b>A</b>	12.5	increases	active transport and osmosis
<b>B</b>	75.0	increases	diffusion and osmosis
<b>C</b>	87.5	decreases	diffusion only
<b>D</b>	12.5	decreases	diffusion and osmosis
<b>E</b>	75.0	decreases	diffusion only
<b>F</b>	87.5	increases	diffusion and osmosis
<b>G</b>	75.0	increases	active transport and osmosis
<b>H</b>	87.5	decreases	active transport and osmosis

- 57 The graph shows the rate of removal of sodium ions from a giant axon in a squid. Between 100 and 230 minutes, a reversible inhibitor of mitochondrial activity was present.

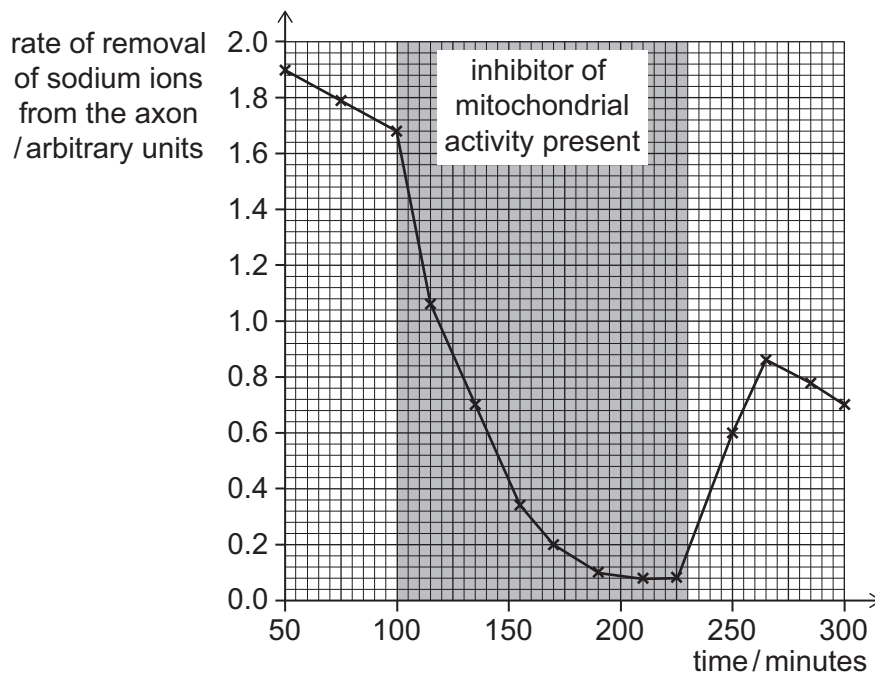

Which of the following statements is/are correct?

- 1 The removal of sodium ions across the cell surface membrane of the axon is an active process requiring ATP.
  - 2 The concentration of sodium ions in the axon must increase after the inhibitor has been removed.
  - 3 In the 50 minutes before the inhibitor was added, the rate of removal of sodium ions from the axon decreases by  $4.4 \times 10^{-3}$  arbitrary units per minute.
- A none of them
- B 1 only
- C 2 only
- D 3 only
- E 1 and 2 only
- F 1 and 3 only
- G 2 and 3 only
- H 1, 2 and 3

58 The diagrams show some stages of mitosis and meiosis in a healthy human male.

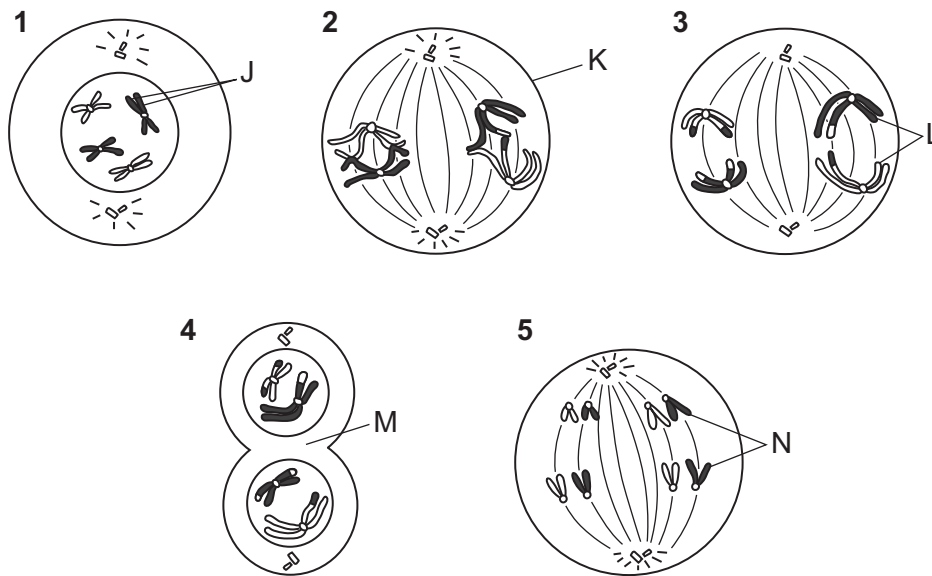

Which row identifies the correct process, the stage of that process, and label?

	<i>diagram number</i>	<i>process</i>	<i>stage</i>	<i>label</i>
<b>A</b>	1	mitosis	prophase	J: paired homologous chromosomes
<b>B</b>	2	meiosis	metaphase 1	K: nuclear membrane of sperm cell
<b>C</b>	3	meiosis	anaphase 2	L: bivalents being separated
<b>D</b>	4	meiosis	telophase 1	M: cleavage of cytoplasm
<b>E</b>	5	mitosis	metaphase	N: sister chromatids

- 59 The family tree shows inheritance of the alleles for one characteristic in a mammal. The gene for this characteristic was found on a non-sex chromosome in the nucleus.

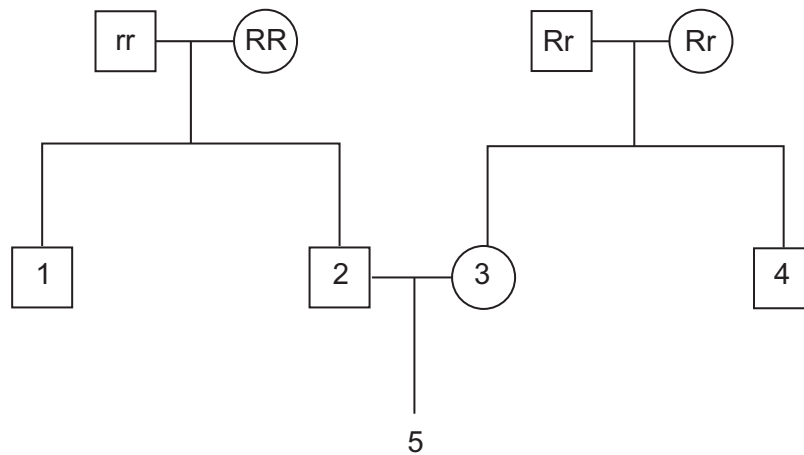

What is the probability that individual 5 is homozygous for the allele R?

- A 0
- B 0.25
- C 0.33
- D 0.5
- E 0.67
- F 0.75
- G 1

- 60** A particular functional protein consists of two smaller chains of amino acids joined together, chain P and chain Q. A group of scientists made this protein using bacterial cells.

They created recombinant plasmid R by inserting the genes for chain P and chain Q into a plasmid. They also inserted a gene for an antibiotic resistance protein into the plasmid so that cells containing the recombinant plasmid could be selected using antibiotics.

A map of the recombinant plasmid is shown:

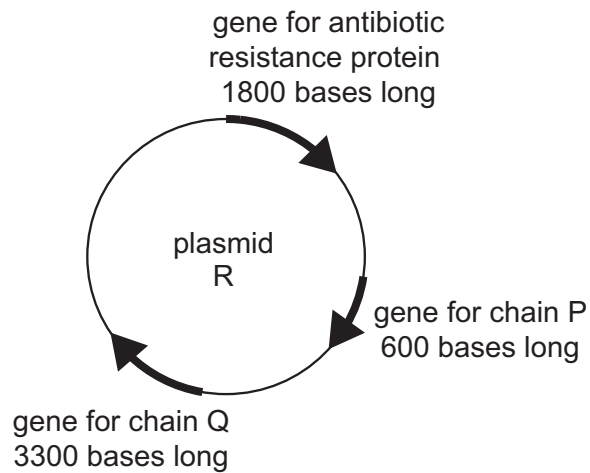

This process is not efficient and must be carried out several times to be certain of creating plasmid R.

Four plasmids were made and individually moved into four bacterial cells, labelled W, X, Y and Z.

The proteins encoded by the genes in the plasmid in the bacterial cells were checked by separating the proteins based on their mass, producing the results as shown in the following diagram.

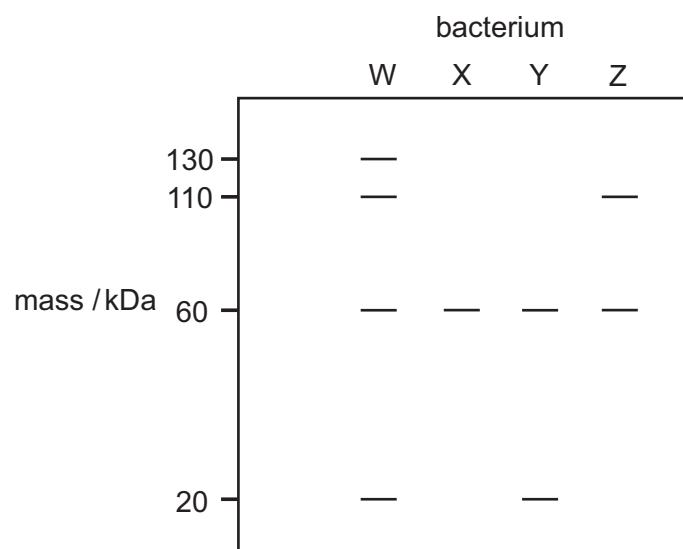

Each band represents a protein or amino acid chain of the given mass.

Assume that one amino acid has a mass of 0.1 kDa.



**60** Which of the following statements is/are correct?

- 1** W is the only bacterium with the fully functional protein.
  - 2** The proteins/amino acid chain(s) in Y and Z are from bacteria that can each only produce one of the parts of the functional protein.
  - 3** The DNA ligase enzymes may not have functioned as intended when creating the plasmid that is in bacterium X.
- A** none of them
- B** 1 only
- C** 2 only
- D** 3 only
- E** 1 and 2 only
- F** 1 and 3 only
- G** 2 and 3 only
- H** 1, 2 and 3

**BLANK PAGE**

**BLANK PAGE**

